

OPERA America's
NATIONAL OPERA CENTER

RENTAL OVERVIEW

2023–2024



OPERA
AMERICA

Introduction

OPERA America's National Opera Center is a communal home for opera and the performing arts in New York City. Whether you're a regular guest or a newcomer to our space, we invite you into our custom-built facility for performances, rehearsals, auditions, recordings, meetings, special events, networking, and more

Make yourself comfortable in clean, modern, and acoustically excellent spaces that accommodate a variety of activities, ranging from solo practice and teleconference meetings to recitals and workshops.



Enjoy regularly tuned pianos in all studios and halls.

Take advantage of affordable recording and technical packages that make it easy to record your material or livestream an event.



OPERA AMERICA MEMBERS ENJOY 25% OFF ALL STANDARD RATES!

Learn more about membership benefits on page 15.

Contents

- 03** Multipurpose Spaces
 - 04** Marc A. Scorca Hall
 - 05** Rehearsal Hall
 - 06** Charles MacKay Studio
 - 07** Private Studios
 - 09** Studio Happy Hours
 - 10** Meeting Rooms
 - 12** Recording Packages
 - 13** Technical Add-Ons
 - 15** Services & Amenities
 - 16** Member Benefits
 - 17** Visitor Information
-

Technical Addendum

- 18** Rules & Regulations
 - 20** Floor Layouts
 - 22** Freight Elevator
 - 23** Floor Plans
-

**BOOK YOUR
SPACE TODAY**

Reservations@operaamerica.org
212.796.8630



Multipurpose Spaces

OPERA America's National Opera Center offers you a selection of versatile performance, rehearsal, meeting, and event spaces custom-built to suit the needs of the opera and performing arts industries.

Basic		Premium	
MARC A. SCORCA HALL			
Main Hall Capacity:	15	Main Hall Capacity:	72
Member Hourly Rate:	\$156	Member Hourly Rate:	\$181
Standard Hourly Rate:	\$208	Standard Hourly Rate:	\$233
Includes 2 tables, 15 music stands, 15 chairs, and green room. Does not include special setup requests other than basic audition setup, or access to technical packages.		Lobby Capacity: 72	
Minimum rental: 1 hour		Member Hourly Rate: \$27	
		Standard Hourly Rate: \$36	
		Includes enhanced setup, ability to book technical equipment and services, and the option to rent the Pamela J. Hoiles Reception Lobby.	
		Minimum rental: 2 hour	
REHEARSAL HALL			
Capacity:	15	Capacity:	60
Member Hourly Rate:	\$105	Member Hourly Rate:	\$125
Standard Hourly Rate:	\$140	Standard Hourly Rate:	\$160
Includes 2 tables, 15 music stands, and 15 chairs. Does not include special setup requests other than basic audition setup, or access to technical packages.		Includes enhanced setup and ability to book technical equipment and services.	
Minimum rental: 1 hour		Minimum rental: 2 hours	
CHARLES MACKAY STUDIO			
Capacity:	15	Capacity:	30
Member Hourly Rate:	\$66	Member Hourly Rate:	\$76
Standard Hourly Rate:	\$88	Standard Hourly Rate:	\$98
Includes 2 tables, 15 music stands, and 15 chairs. Does not include special setup requests other than basic audition setup, or access to technical packages.		Includes enhanced setup.	
Minimum rental: 1 hour		Minimum rental: 2 hours	

NONPROFITS RECEIVE 10% OFF STANDARD RATES

Scorca Hall, Rehearsal Hall, and MacKay Studio may be booked day-of for 50% off the rates listed above, pending availability.

Rates are valid as of July 1, 2023, and are subject to change without notice. Additional charges may apply for use of equipment.

Marc A. Scorca Hall

The centerpiece of the National Opera Center, Marc A. Scorca Hall offers you an impressive yet intimate space for performances, recitals, private auditions, and recordings. The acoustically excellent venue features a regularly tuned Yamaha 7' grand piano, raised stage with theatrical lighting, professional audio-visual recording, projecting and streaming systems, and a green room.



Features

- 55' x 21' with 20' arched ceiling
- Wings/backstage space
- Recording-ready
- Adjustable acoustic panels
- Wood floor
- Platform stage
- Flexible seating
- Green room

Equipment

- 7' Yamaha grand piano
- Theatrical lighting system
- Music stands
- Video projection system, including motorized screen
- Additional audio/visual equipment available by request



Pamela J. Hoiles Reception Lobby

- Natural and fluorescent lighting
- Cement floor
- High and low tables available by request
- Capacity: 72

Capacity

- Basic rate: 15
- Theater seating: 72
- Hollow square seating: 40
- U-shape seating: 35

	BASIC	PREMIUM
	Min 1 Hr	Min 2 Hrs
Member Hourly	\$156	\$181
Standard Hourly	\$208	\$233
NONPROFITS RECEIVE 10% OFF STANDARD RATES		

Rates are valid as of July 1, 2023, and are subject to change without notice. Additional charges may apply for use of equipment.

Rehearsal Hall

The Rehearsal Hall allows you the creative flexibility of running a workshop, producing a chamber concert, holding auditions, or hosting a special event. The adaptable space features a regularly tuned Steinway Hamburg D 9' grand piano, adjustable lighting, and a professional built-in audio-visual recording system.



Features

- 49' x 24' with 11' ceiling
- Acoustic panels
- Wood floor

Equipment

- Steinway Hamburg D 9' grand piano
- Incandescent and fluorescent lighting
- Music stands
- Tables available by request
- Additional audio/visual equipment available by request
- Video projection system, including motorized screen

Capacity

- Basic rate: 15
- Theater seating: 60
- Hollow square seating: 40
- U-shape seating: 35
- Standing reception: 60

	BASIC	PREMIUM
	Min 1 Hr	Min 2 Hrs
Member Hourly	\$105	\$125
Standard Hourly	\$140	\$160
NONPROFITS RECEIVE 10% OFF STANDARD RATES		

Rates are valid as of July 1, 2023, and are subject to change without notice. Additional charges may apply for use of equipment.

Charles MacKay Studio

The multipurpose Charles MacKay Studio offers you a mid-sized venue for auditions, rehearsals, receptions, and meetings. With natural and overhead lighting, the room features a regularly tuned Yamaha 5'3" grand piano and a built-in teleconference setup.



Features

- 27' x 22' with 10' ceiling
- West-facing windows
- Wood floor

Equipment

- Yamaha 5'3" grand piano
- Video presentation system, including 60" HD television
- Natural and fluorescent lighting
- Music stands
- Tables available by request

Capacity

- Basic rate: 15
- Theater seating: 30
- Hollow square seating: 24
- U-shape seating: 20
- Standing reception: 30

	BASIC	PREMIUM
	Min 1 Hr	Min 2 Hrs
Member Hourly	\$66	\$76
Standard Hourly	\$88	\$98
NONPROFITS RECEIVE 10% OFF STANDARD RATES		

Rates are valid as of July 1, 2023, and are subject to change without notice. Additional charges may apply for use of equipment.

Booking a studio?
Enjoy Studio Happy Hours rates starting at \$5 per hour during select times. See p. 9 for details.

Private Studios



Studio 711

PREMIUM STUDIOS allow you the most flexibility in your practice needs, with ample space for theatrical coachings or ensemble rehearsals.

FEATURES

- Yamaha 5'3" grand piano
- Musicians' chairs
- Music stands
- Wall mirror
- Tables available by request
- Fluorescent and natural lighting (in select rooms)

Members: \$27/hour | Standard: \$36/hour

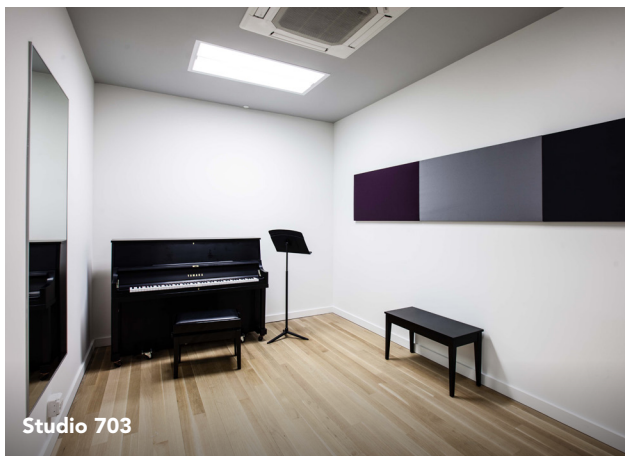

Studio 703

STANDARD STUDIOS provide you with mid-sized, private rooms for solo practice, coaching sessions, or small ensemble rehearsals.

FEATURES

- Yamaha 45" upright piano
- Musicians' chairs
- Music stands
- Wall mirror
- Tables available by request
- Fluorescent and natural lighting (in select rooms)

Members: \$21/hour | Standard: \$28/hour



Studio 801

ECONOMY STUDIOS offer you our most affordable spaces for private practice or small group coaching.

FEATURES

- Yamaha 45" upright piano
- Musicians' chairs
- Music stands
- Wall mirror
- Fluorescent lighting

Members: \$15/hour | Standard: \$20/hour

Rates are valid as of July 1, 2023, and are subject to change without notice. Additional charges may apply for use of equipment.

Booking a studio?
 Enjoy Studio Happy Hours rates starting at \$5 per hour during select times. See p. 9 for details.

Private Studios

The National Opera Center’s nine studios provide private space for solo practice, coachings, or small ensembles. Available in three tiered sizes, all studios include regularly tuned pianos, musicians’ chairs, music stands, and wall mirrors.

	Room	Capacity	Dimensions	Hourly Member Rate	Hourly Standard Rate
Premium Studios	Studio 706 Virginia B. Toulmin Studio	12	W: 17'5" D: 14'8" H: 10'	\$27	\$36
	Studio 710	8	W: 15'2" D: 12'10" H: 10'		
	Studio 711* Beverly Sills Studio	12	W: 18' D: 15'2" H: 10'		
Standard Studios	Studio 703 Elizabeth and Jean-Marie Eveillard Studio	6	W: 15'6" D: 9'6" H: 10'	\$21	\$28
	Studio 705* Jill and William Steinberg Studio	4	W: 13'8" D: 8'6" H: 10'		
	Studio 712* Dr. Steve and Rochelle Prystowsky Studio	8	W: 14'2" D: 11'2" H: 10'		
Economy Studios	Studio 801 Jane A. Gross Studio	4	W: 10'6" D: 10'5" H: 10'	\$15	\$20
	Studio 802 Jane and Mort Robinson Studio	4	W: 10'7" D: 10'6" H: 10'		
	Studio 803	4	W: 10' D: 8'9" H: 10'		

* Studio has windows with natural light.

Rates are valid as of July 1, 2023, and are subject to change without notice. Additional charges may apply for use of equipment.

Studio Happy Hours

Studio Happy Hours make vocal, instrumental, and theatrical rehearsals at OPERA America's National Opera Center even cheaper — with rates starting at just \$5 per hour.

During select times every week, individuals seeking space for creative rehearsal can book the facility's economy, standard, and premium studios at the special Studio Happy Hours rates.

The Studio Happy Hours program is made possible by the New York State Council on the Arts with the support of the Office of the Governor and the New York State Legislature.

Special Hours & Rates

Studio Happy Hours Rates	Economy Studios	\$5 per hour (reduced from \$20)
	Standard Studios	\$8 per hour (reduced from \$28)
	Premium Studios	\$10 per hour (reduced from \$36)



Studio Happy Hours rates are:

- Available to individuals, small ensembles, and organizations working in opera, musical theater, chamber music, choruses, piano performance, theater, comedy troupes, and other disciplines.
- Reserved for creative rehearsal. Use of the studios for paid teaching, coaching, lessons, auditions, classes, workshops, or other business or commercial activities is not eligible for the subsidized rates.
- Only available for the Opera Center's economy, standard, and premium studios.



Regular Weekly Hours

- Monday – Friday: 10:00 a.m. – 12:00 p.m., 8:00 p.m. – 10:00 p.m.
- Saturday – Sunday: 6:00 p.m. – 10:00 p.m.

Studio Happy Hours are available February 5 through August 31, 2024. 80 hours are available each week at the special rates on a first-come, first-served basis. No individual or organization can book more than 200 hours total during the calendar year at the special rates. Standard National Opera Center booking rules and cancellation policy apply.

Meeting Rooms

The National Opera Center gives you the choice of scheduling your next meeting around an executive board table or in a casual conference room.

Leirvik Board Room

The Barbara and Ronald Leirvik Board Room gives you a professional setting for meetings, presentations, teleconferences, and interviews around an executive board table. The room includes an 80" HD television, wireless screen sharing for presentations, and a built-in Zoom teleconference system.



Features

- 31' x 14' with 10' ceiling
- Board table with 15 executive chairs
- Carpeted floor

Equipment

- Video and Zoom teleconferencing capability
- 80" HD television
- Fluorescent lighting

Capacity

- Board table seating: 15
- Mixed seating: 18

Hourly Room Rates

Member:	\$45
Standard:	\$60

NONPROFITS RECEIVE 10% OFF STANDARD RATES

Rates are valid as of July 1, 2023, and are subject to change without notice. Additional charges may apply for use of equipment.

Meeting Rooms

Lesenger Family Conference Room

The Lesenger Family Conference Room offers you a more casual venue for meetings, interviews, or private workspace, tucked away in the Ardis Krainik Research and Reference Library. Available on weekends and weekday evenings, the room may also be combined with the library for intimate special events and receptions.



Features

- 18' x 14' with 10' ceiling
- Conference table with 12 chairs
- Concrete floor

Equipment

- Natural and fluorescent lighting

Capacity

- Conference table seating: 12
- Standing reception with Krainik Library: 30



Krainik Library

- 18' x 16'
- Natural and fluorescent lighting
- Cement floor
- High and low tables available by request
- Capacity: 30

Hourly Room Rates

Member:	\$54
Standard:	\$72

With Krainik Library

Member:	\$69
Standard:	\$92

NONPROFITS RECEIVE 10% OFF STANDARD RATES

Rates are valid as of July 1, 2023, and are subject to change without notice. Additional charges may apply for use of equipment.

Recording Packages

The Opera Center offers all-inclusive audio and video recording packages to help you prepare your audition materials or share a new project.

PLEASE NOTE: Recording Session rates include the hourly rental fee for Marc A. Scorca Hall.

Audio Recording Session in Marc A. Scorca Hall

An audio recording package includes a recording engineer and microphones. Editing is available for \$125/hour. Ten business days after your recording session, you will receive mixed-down audio tracks in both WAV and MP3 formats.

	Members	Non-Members
	Each Hour	Each Hour
Audio Recording Session	\$210	\$280

Video Recording Session in Marc A. Scorca Hall

A video recording package includes a recording engineer and microphones. Ten business days after your recording session, you will receive the following as a finished product: A high-definition video recording of the session in MP4 format, as well as separate audio tracks in both WAV and MP3 formats.

	Members	Non-Members
	Each Hour	Each Hour
Single-Camera Video Recording Session	\$255	\$340
Multi-Camera Video Recording Session	\$300	\$400

Technical and Recording Add-Ons

The Opera Center events team can help you customize your visit with affordable technical support for audio-visual needs and flexible audio and video recording setups.

Event Recording • Projection • Reception and Meeting Equipment • House Staff
Livestream Broadcasting • Audio Amplification

PLEASE NOTE: The rates below are for add-ons only and do not include the price of room rentals.

Event Recording <i>Only available in select spaces. Includes engineer and microphones.</i>	Each hour
--	------------------

Single Camera

Marc A. Scorca Hall	\$150
Rehearsal Hall	\$135
Livestream in Marc A. Scorca Hall	\$75 (flat rate per event)

Multi-Camera

Marc A. Scorca Hall	\$200
Livestream in Marc A. Scorca Hall	\$125 (flat rate per event)

Editing *(Recommended 1 hour per hour of recorded footage)*

\$125

AUDIO/VIDEO	Full day
--------------------	-----------------

Audio Amplification *Does not include a technician throughout the event. See next page for event staff rates.*

One Wired Microphone (with PA System) <i>(Maximum available: 4)</i>	\$50
Additional Wired Microphone	\$30
One Wireless Microphone (with PA System) <i>(Maximum available: 2)</i>	\$75
Additional Wireless Microphone	\$50

Projection *Does not include a technician throughout the event. See next page for event staff rates.*

Scorca Hall <i>(does not include computer)</i>	\$150
Rehearsal Hall <i>(does not include computer)</i>	\$50

Add-Ons

Furniture and Meeting Equipment	Full day
Flip Chart/Easel <i>(Maximum available: 3)</i>	\$25 each
Lectern <i>(Maximum available: 3)</i>	Included *
5' x 2.5' Table	Included *
5' x 1.5' Table	Included *
Table Linen	\$25 each
Table Skirt	\$30 each
Table Linen & Skirt Combo	\$50 each

* Complimentary equipment and services are provided, pending availability, on a first-come basis.

Staff and Additional Services	
House Manager <i>(2-hour minimum)</i>	\$40/hr.
Audition Monitor <i>(2-hour minimum)</i>	\$40/hr.
Technical Engineer <i>(2-hour minimum)</i>	\$125/hr.
Early Open <i>(prior to 10:00 a.m.)</i>	\$100/hr.
Late Close <i>(after 10:00 p.m.)</i>	\$150/hr.
Off-Hour Freight Elevator Access <i>Weekdays, 5:00–10:00 p.m. Weekends, 10:00 a.m.–10:00 p.m.</i>	\$150/day
Piano Tuning	\$225/day

Services and Amenities

Whether you come for lessons, a meeting with colleagues, or your next recital, OPERA America's National Opera Center is outfitted to make your life easy.



Complimentary Wi-Fi Access

Enjoy free internet throughout the Opera Center.

Lounge with Vending Machines

Grab a snack, refreshment, or hot cup of coffee in the convenient artists' lounge.

Storage Lockers

Store your scores or other personal items for the day or between visits.

Locker Rental Rates

Day: **\$5**

Week: **\$25**

Month: **\$50**

Research and Score Libraries

The Opera Center houses two library collections dedicated the operatic art form. The Ardis Krainik Research and Reference Library and the Baisley Powell Elebash Score and Recording Library offer over 2,000 books, recordings, scores, and historically significant documents that you can peruse when visiting. These include the annotated conductor scores of the Julius Rudel Archive. All collections are non-circulating.



Member Benefits

OPERA America membership unites those working, volunteering, and finding enjoyment in opera around a shared vision for the future of the art form. We provide access to learning materials, professional opportunities, and the resources of our National Opera Center in New York City.

Enjoy the perks of membership at the National Opera Center:

- Save 25% off all space rentals.
- Take advantage of priority advance booking on spaces

Professional Company Members

12 months in advance

Associate, Business, and Educational Members

9 months in advance

Individual Members

6 months in advance

- Save with member pricing on OPERA America programs, including OPERA America Onstage events and career development programs for artists.



Membership Types

Organizational Membership Opera companies, educational institutions, industry businesses, and other arts entities benefit from OPERA America’s collective knowledge and shared resources, as well as learning opportunities, professional development, and discounts.

Individual Membership Artists, administrators, educators, trustees, and appreciators stand with OPERA America in support of opera. They benefit from resources, opportunities, and discounts to advance careers and deepen appreciation of the art form.

Learn more at operaamerica.org/Membership

Visitor Information

330 Seventh Avenue, 7th Floor • New York, NY 10001

Open Daily, 10:00 a.m. – 10:00 p.m.

Reservations@operaamerica.org • 212.796.8630

OPERA America's National Opera Center is centrally located in Midtown Manhattan on the northwest corner of 29th Street and Seventh Avenue. Enter on Seventh Avenue, and take the elevator to the seventh floor to check in at the front desk. The facility spans the seventh and eighth floors of the building, with an internal staircase providing access between them. There is no external entry to the eighth floor.

To access the National Opera Center from 7:00 p.m. to 10:00 p.m., use the intercom located to the right of the building's street-level entrance.

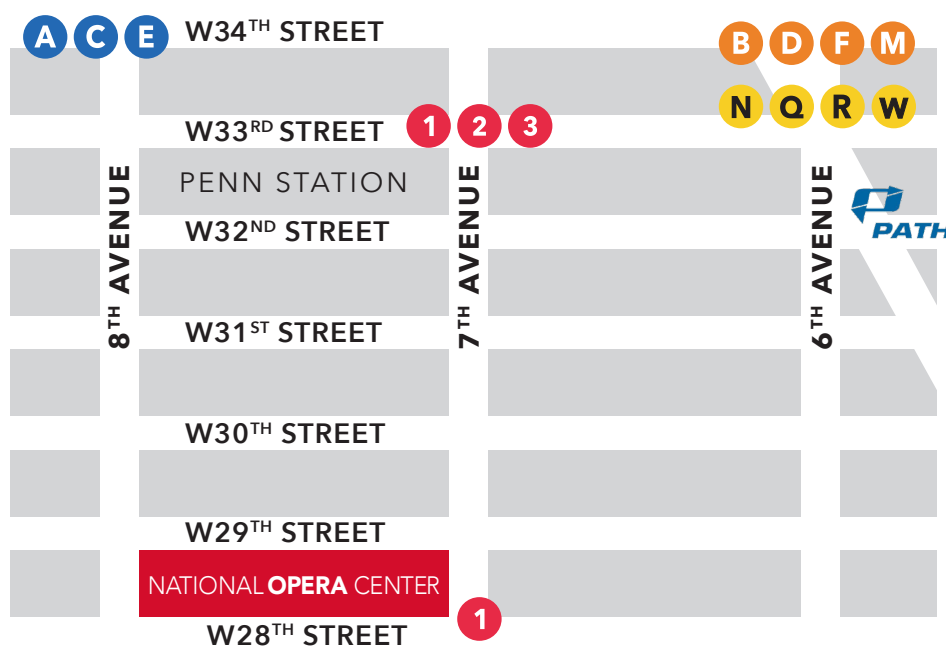

Getting Here

You can reach us using more than a dozen subway lines, including the 1 train (at 28th Street), 1/2/3/A/C/E trains (at Penn Station), B/D/F/M/N/Q/R/W trains (at 34th Street-Herald Square). You can also arrive by Amtrak or PATH service, as well as regional bus lines and airport shuttles.

Accessibility

The Opera Center features ground-level entry with elevators to the venue. All spaces are wheelchair accessible, and modular seating can be arranged to accommodate wheelchair users for all programs and performances. Handicap-accessible restrooms are available on the seventh floor. For more information about accessibility, contact us at 212.796.8630 or Reservations@operaamerica.org.

Rules and Regulations for Rental and Use of the National Opera Center Facilities

DEPOSITS, CHANGES, AND CANCELLATIONS

1. For all contracted events, a deposit equal to half of the total rental fee is required upon receipt of the signed contract to confirm a reservation at the National Opera Center. All additional fees and balances must be paid in full a minimum of one week prior to use.
2. If a cancellation of any portion or the entirety of a rental is necessary, the Opera Center must be notified immediately. To receive a refund, cancellations must be submitted in writing. Deposits are 100% refundable if the reservation is canceled at least three months in advance of the booking date. Deposits are nonrefundable within three months of the booking date.

Otherwise, cancellation charges are as follows:

- Event Spaces, Equipment, and Services: 100% of contracted amount is due when canceled less than 1 month in advance. (Event Spaces include Scorca Hall, Rehearsal Hall, MacKay Studio, Leirvik Board Room, and Lesenger Family Conference Room.)
 - Vocal Studios: 100% of contracted amount is due when canceled less than 24 hours in advance of reservation start time.
3. If the nature of the event or number of participants changes, the Opera Center must be notified immediately, and no changes may be made within one week prior to the scheduled use. If necessary, fees/deposits will be changed according to applicable rates. The Opera Center reserves the right to disapprove any requested changes.
 4. For inclement weather or emergencies, please note the renter is responsible for the full balance of the rental unless it is determined that the National Opera Center will be closed. In the event of closure, the renter will either be refunded the rental fees or may reschedule the rental at no charge.

5. After receipt of the signed rental agreement, any future changes at the client's request sent via invoice are also considered confirmed and subject to the above cancellation policy.
6. Organizations may not book under individual memberships. For bookings under individual member accounts, the individual must be present for the event and must be the point of contact for all paperwork.
7. Neither party shall be responsible for failure to perform this contract if circumstances beyond their control, including but not limited to: acts of God, governmental authority, or war in the United States that makes it illegal or impossible for the Opera Center to hold the event.

PAYMENT OF FEES

1. Payment of all contracted rental fees must be made at least one week in advance of the scheduled use. Failure to meet this deadline may result in the cancellation of the rental and forfeiture of the deposit. Deposit must be made when the contract is signed.

RENTAL TIME/HOURS

1. Hours requested should include time for the group's special setup and cleanup needs. National Opera Center staff can and will set up basic equipment for "premium use" events, such as chairs and music stands, before the renter enters the space. For "basic use" events, the client is responsible for all setup and strike of materials and must account for that time in the rental. If clients renting "basic use" space leave the halls without striking the Opera Center materials used, they may be subject to premium use fees.
2. Clients will not have access to spaces prior to start time of their booking and need to completely vacate the spaces at the end time of their booking.

3. Clients will not have access to the National Opera Center prior to opening at 10:00 a.m. and must vacate the facility no later than 10:00 p.m., unless they have been approved in advance for an early open or late close.
4. If the event goes beyond the scheduled hours stated on the contract, the client will be asked to vacate the space and will be liable for overage fees.

SET-UP/CLEAN-UP

1. Renters are responsible for setup of the space beyond what is requested in advance of the Opera Center staff. Renters are also responsible for leaving the space exactly as found at the beginning of the rental. Failure to return the space to the condition it was found in will result in additional fees.
2. If the Opera Center staff is responsible for the setup and tear-down, then the renter must make sure all tables and chairs are wiped clean after the rental.
3. Nails, screws, staples, etc., are not permitted for use on walls, floors, ceilings, and fixtures in the Opera Center. Spike tape may be used on floors. Nothing may be affixed to walls.
4. A clear diagram (tables, chairs, and other setup needs) must be submitted to the Opera Center Management at least one week prior to the activity. If not supplied, the setup will not be done in advance.
5. Clients are not permitted to add or remove any furniture from any space. This includes all chairs and tables in the public artists' lounges on the 7th and 8th floors.
6. No signage of any kind may be posted in the ground floor lobby or on the building exterior.

GENERAL FACILITY RULES

1. Prepared piano of any kind is not allowed at the National Opera Center.
2. Dance performance and rehearsal are not allowed at the National Opera Center.
3. No food or drink, except for water, is permitted in Marc A. Scorca Hall.
4. No red wine is permitted in the National Opera Center.
5. Electric micro-mobility devices such as e-bikes and e-scooters are not allowed anywhere in the facility.
6. Failure to adhere to these restrictions may result in substantial cleaning or repair fees.

BUILDING SUPERVISION AND REVOKING A RENTAL

1. An Opera Center representative will be on duty at all times and is responsible for general conduct in the building and enforcement of the rules governing the facilities.
2. Fights, vandalism, or unacceptable behavior occurring during a rental will cause immediate cancellation of the rental with no refund of fees or deposits.
3. The number of attendees cannot exceed the stated fire code capacity of the room rented. The National Opera Center reserves the right to immediately cancel any event that exceeds that code capacity.

OUTSIDE EQUIPMENT AND DELIVERIES

1. All outside equipment must be approved by the Opera Center Technical Manager. All deliveries of said equipment must be scheduled with and approved by the Opera Center Management.
2. All deliveries of supplies, catering, etc., must be approved by Opera Center Management.
3. All wheeled bags, road or instrument cases, or containers of any kind must come up through the freight elevator. The freight elevator is available weekdays from 10:00 a.m. to 5:00 p.m. If the elevator is needed outside of this time frame, Opera Center Management must be informed in advance.
4. Failure to adhere to these policies may result in the rejection of equipment or deliveries from entering the National Opera Center.

By utilizing the National Opera Center, you agree to honor OPERA America's Community Guidelines, which can be viewed at operaamerica.org/CommunityGuidelines.

TICKETED EVENTS, PUBLICITY, AND PRESS

1. If a rental involves an admission charge or registration fee, the renter is responsible for all ticketing services. The National Opera Center is NOT to be listed as the presenter or contact for ticket information or as the location for advanced registration/ticket sales, or as a program sponsor.
2. The National Opera Center reserves the right to review all promotional materials before they are sent to press.
3. Applicant acknowledges that the National Opera Center is in no way responsible for publicizing rental events. Organizational members of OPERA America may post events to the OPERA America online calendar via their membership portal.

ADDITIONAL STAFFING

1. The National Opera Center can provide, for an additional fee and subject to staff availability, the following additional staff roles:

Audition Monitor

- Reports to client at the start of their contracted shift.
- Checks in participants while collecting audition materials for the audition committee.
- Ensures participants take the space when they are meant to, which usually requires tracking time, and has the next participant ready when one walks out.

House Manager

- Reports to client at the start of their contracted shift.
- Checks in guests based on list provided by client.
- Sells tickets or merchandise provided by client.
 - o Client must instruct staffer on how to take payments and provide any point-of-sale hardware the staffer may need.
- Pre-event: Closes house doors, dims house lights, turns stage lights on, and makes preshow announcement.
 - o Client must provide script if a pre-event announcement is requested.

- Seats late arrivals.
- Post-event: Opens house doors and turns house lights on.

CATERING, FOOD, AND DRINK

1. Alcohol may be served, but not sold.
2. No food or drink, except for water, is permitted in Marc A. Scorca Hall.
3. No red wine is permitted in the National Opera Center.
4. All outside food and beverage must be approved in advance by Opera Center Management.
5. Only premium rentals are allowed to add catering and, if the booking is in Marc A. Scorca Hall, a separate reception space must be reserved.

OTHER

1. No one shall perform any work nor make additions to or subtractions from Opera Center pianos.
2. The Opera Center provides several preset lighting options. Renters are not permitted to refocus instruments.
3. Each individual and/or organization presenting public performances will be required to have liability insurance of \$1,000,000 with OPERA America/National Opera Center named as additional insured. OPERA America retains the right to ask for proof of insurance at any time. This requirement may be waived for members of OPERA America at management's discretion.
4. The National Opera Center is not responsible for streaming and recording permissions of licensed materials.
5. Smoking and vaping are not permitted anywhere in the facility.
6. Clients of the National Opera Center are subscribed to OPERA America's email list; you may modify your subscription preferences or unsubscribe if you wish.

LIABILITY AND INDEMNITY

Applicant hereby agrees to hold OPERA America/The National Opera Center, the individual members thereof, and employees free and harmless from any loss, damage, liability, and cost of expense that may arise in any way by such loss or occupancy of the National Opera Center facilities.

7th Floor Layout

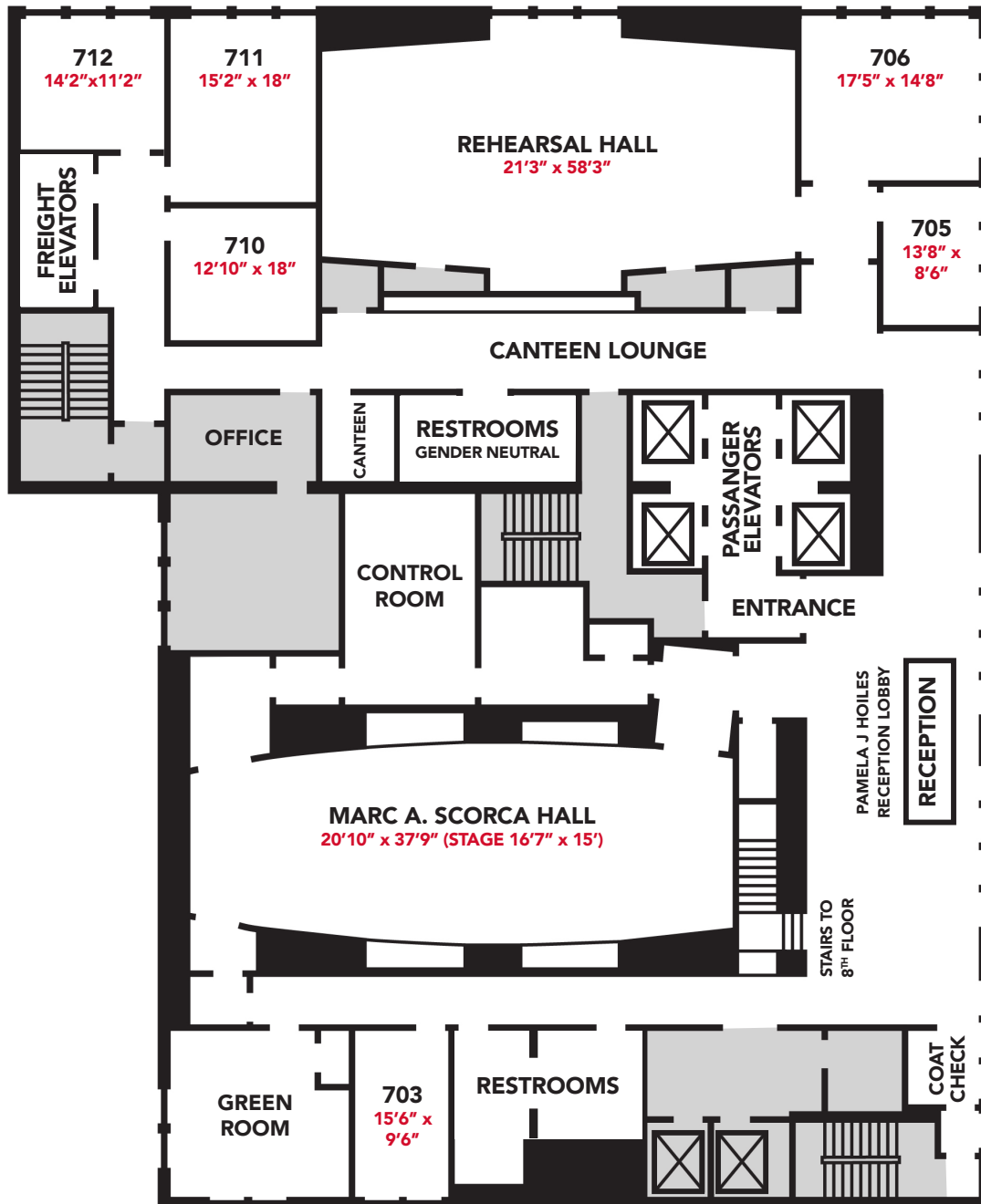

8th Floor Layout

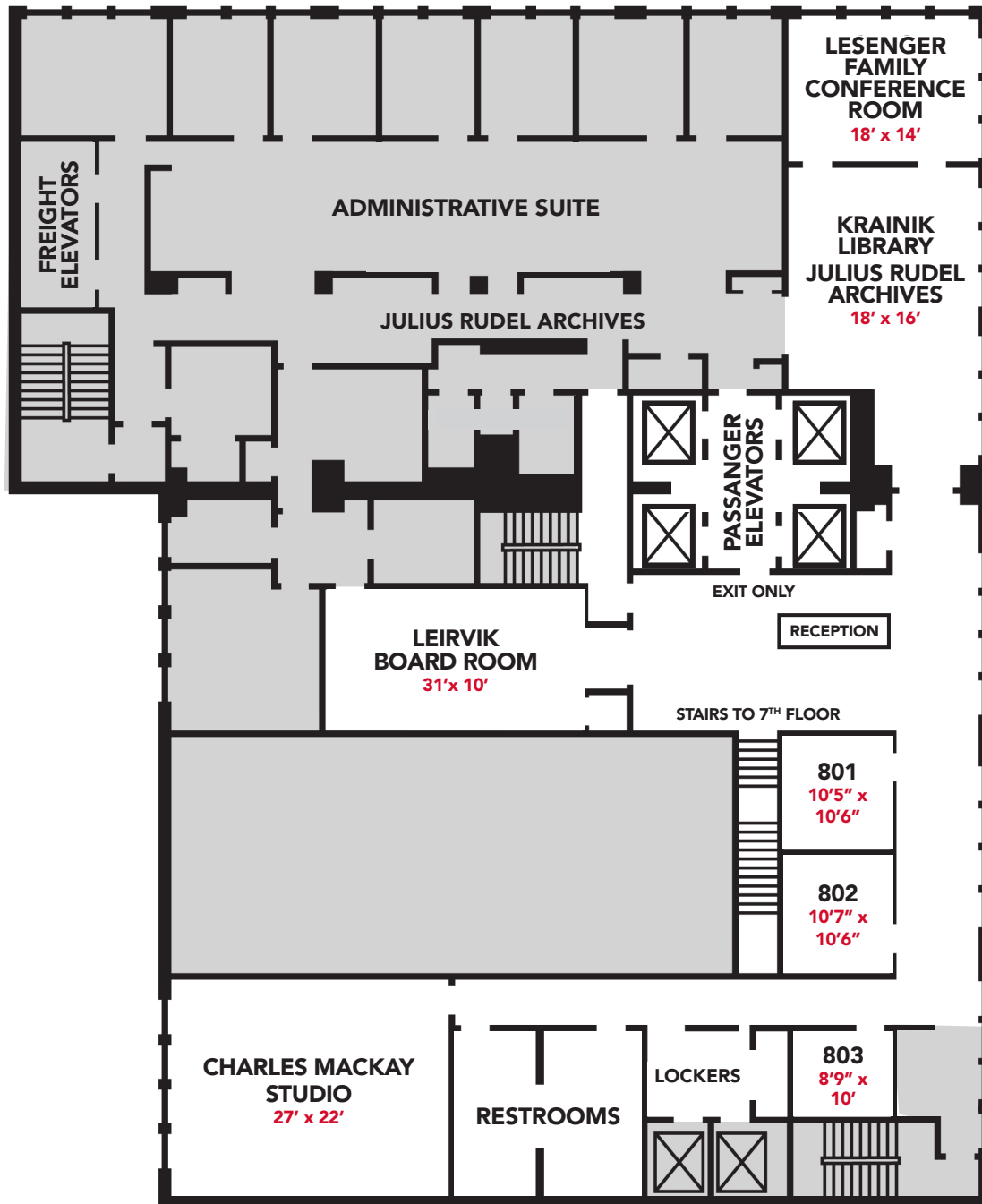

Freight Elevator

Front View

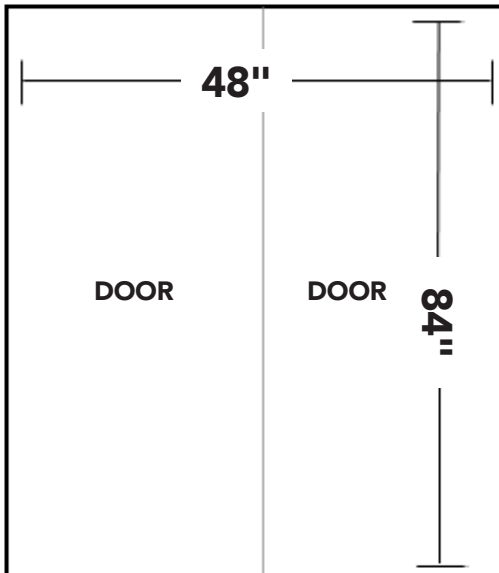

Top View

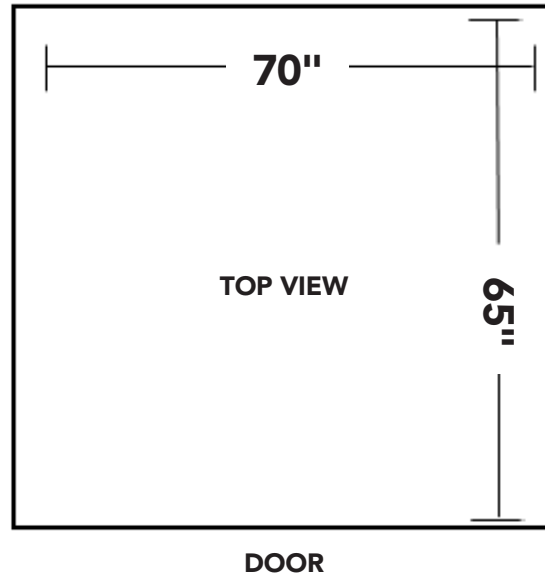

Side View

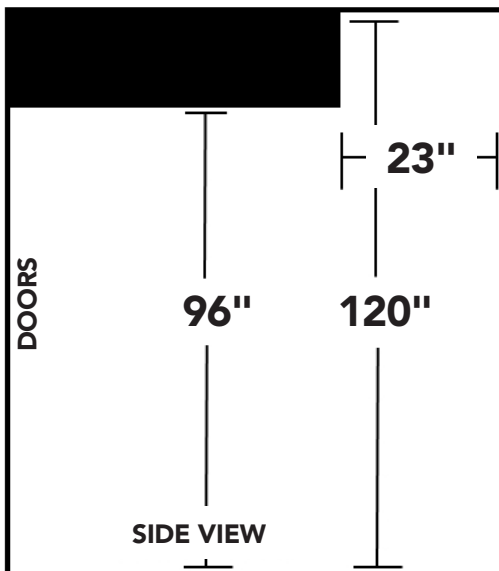

Freight Specifications

Operating Hours:	Monday–Friday, 10:00 a.m.–5:00 p.m. \$150 fee for operation outside of normal hours
Max Capacity:	2,500 lbs.
Ceiling Height:	8'0"
Entrance:	Accessible at street level on 29 th Street

FLOOR PLANS

Marc A. Scorca Hall

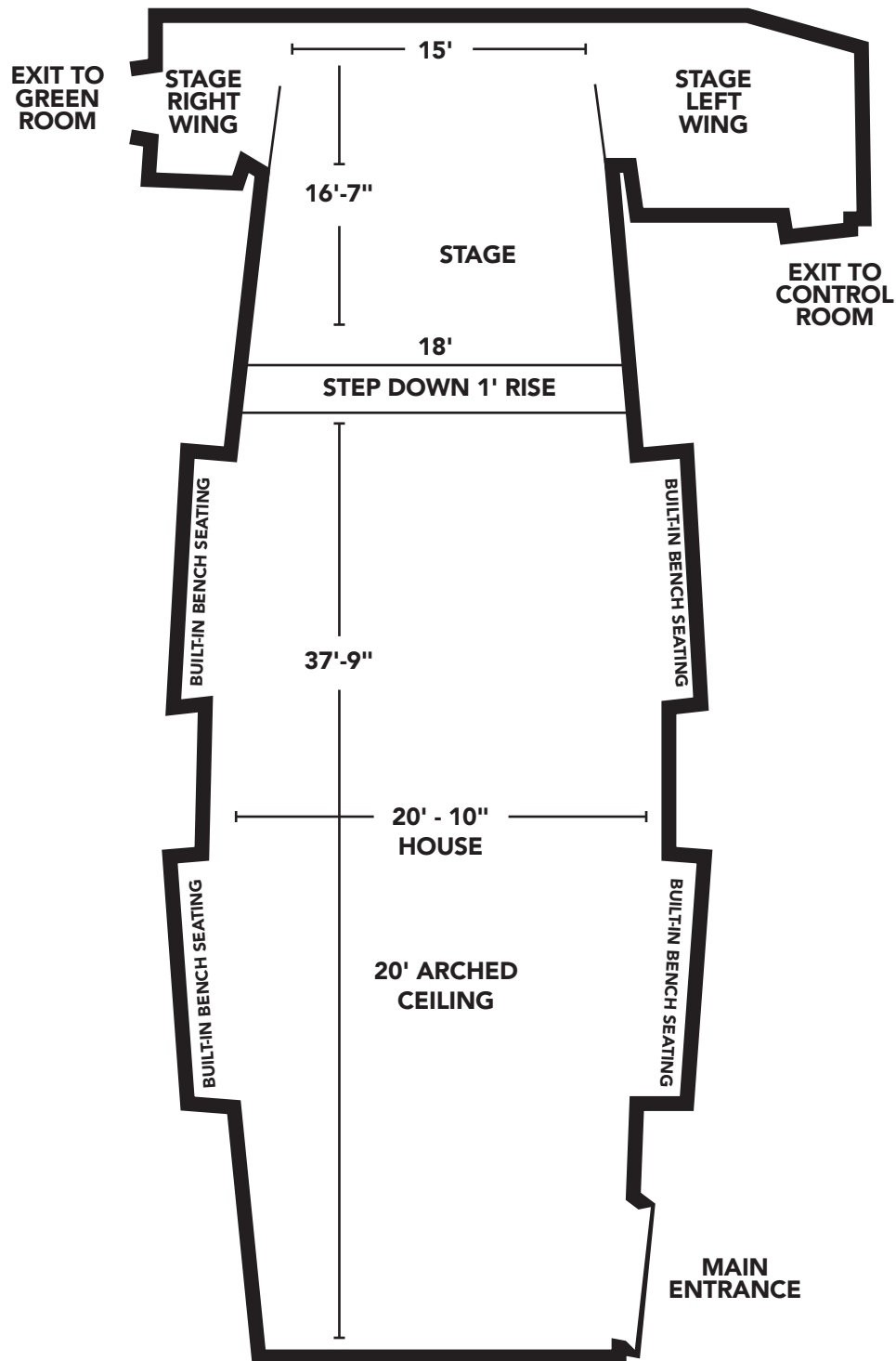

FLOOR PLANS

Rehearsal Hall

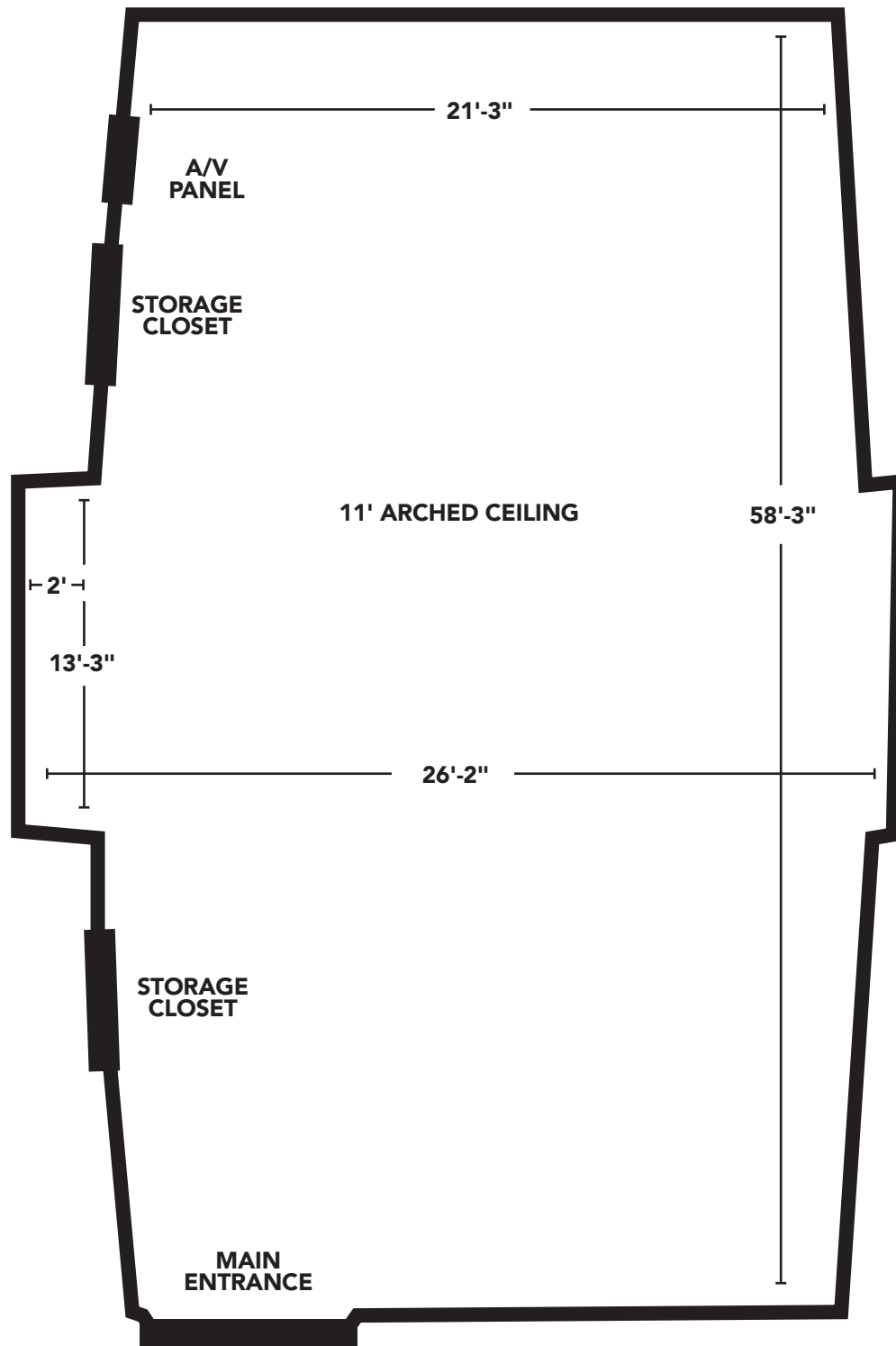

FLOOR PLANS

OPERA
AMERICA

The Charles MacKay Studio

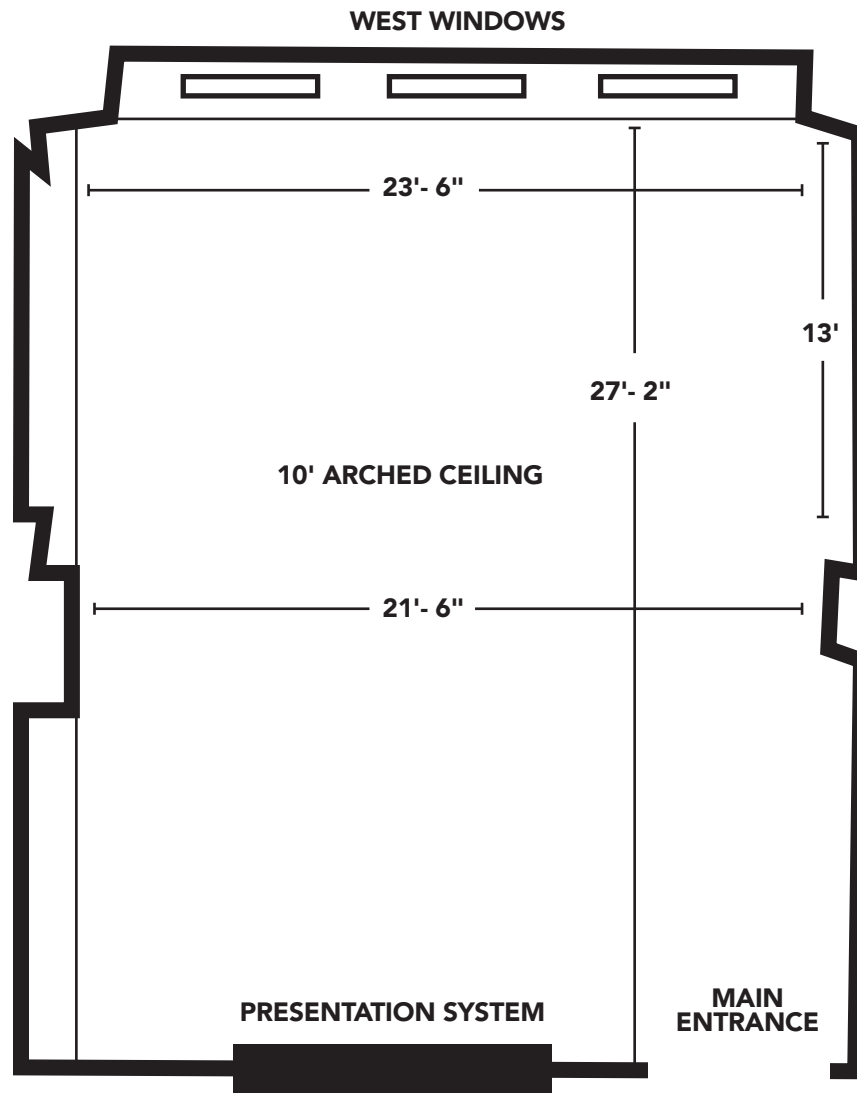

FLOOR PLANS

Barbara and Ronald Leirvik Board Room

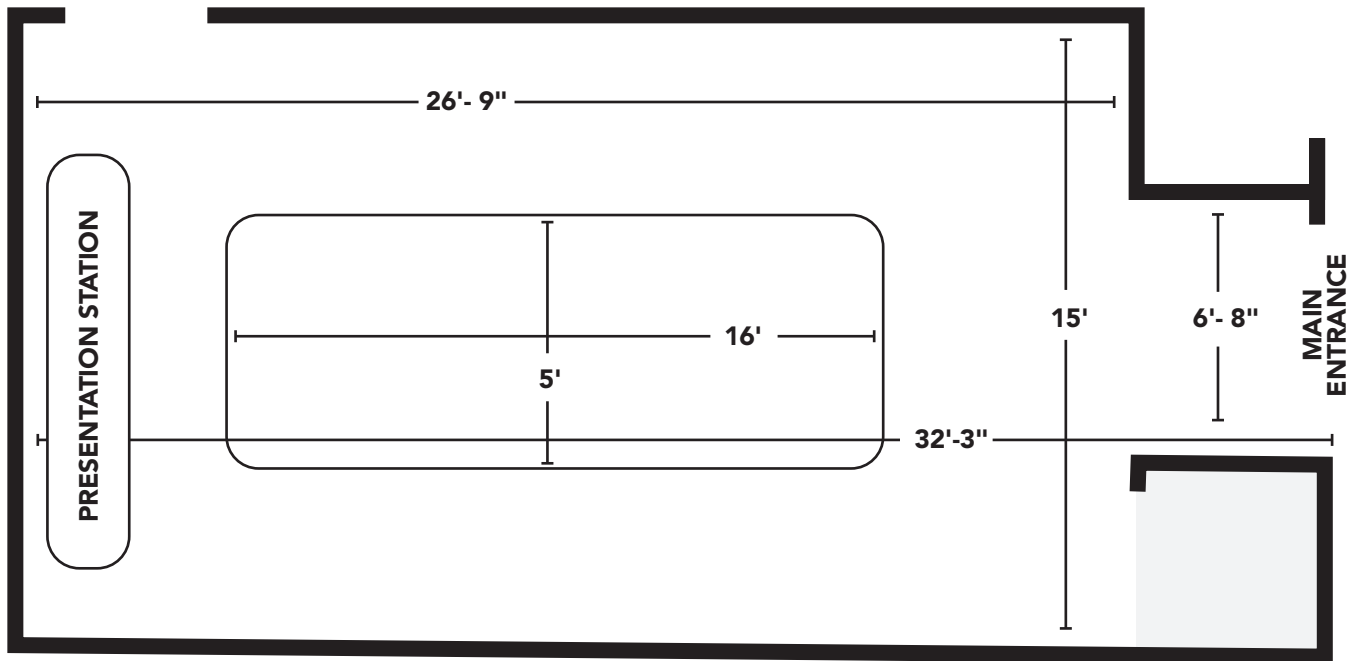

Board Room Specifications

Table Dimensions: 16' x 5'

Table Seating Capacity: 15

Mixed Seating Capacity: 18

FLOOR PLANS

Studios

Studio 703

147 sq ft | 10' Ceiling

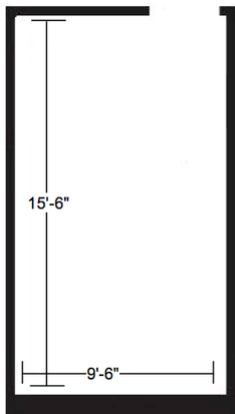
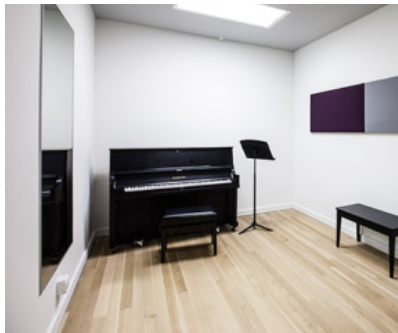

Studio 705

115 sq ft | 10' Ceiling

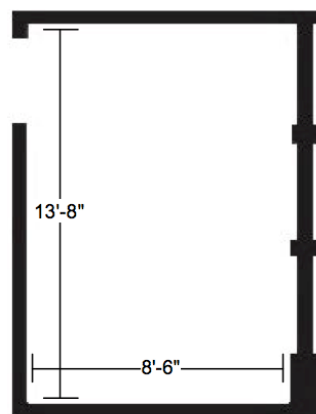

Studio 706

253 sq ft | 10' Ceiling

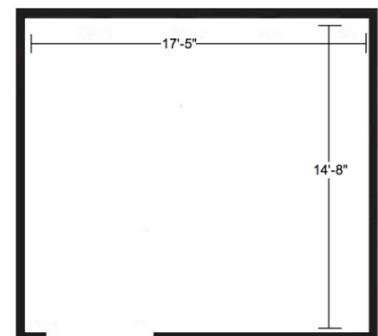

FLOOR PLANS

Studios

Studio 710

195 sq ft | 10' Ceiling

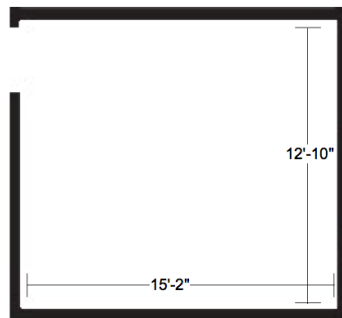

Studio 711

270 sq ft | 10' Ceiling

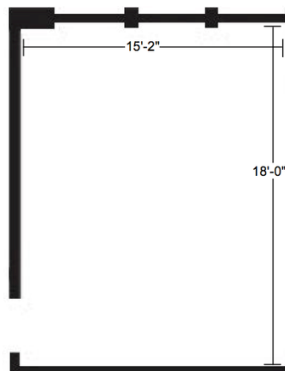
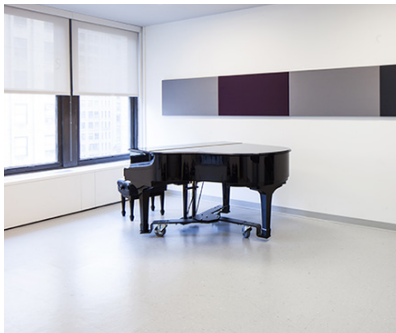

Studio 712

154 sq ft | 10' Ceiling

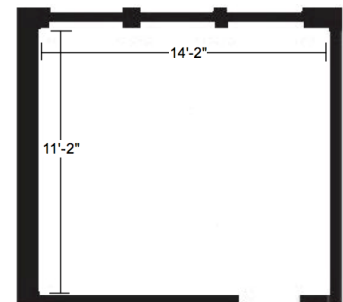
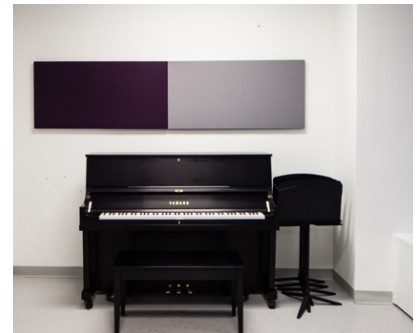

FLOOR PLANS

Studios

Studio 801

110 sq ft | 10' Ceiling

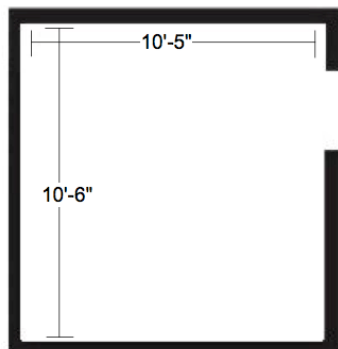
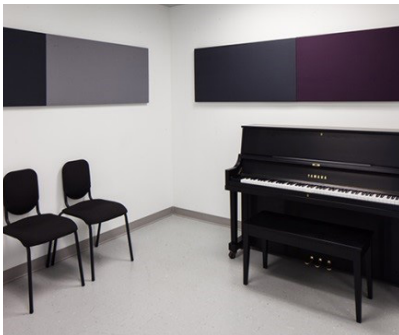

Studio 802

110 sq ft | 10' Ceiling

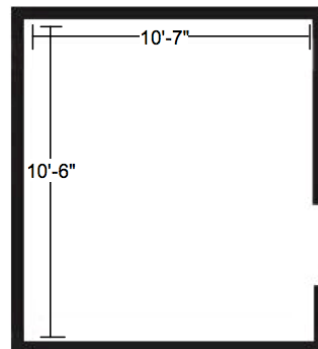
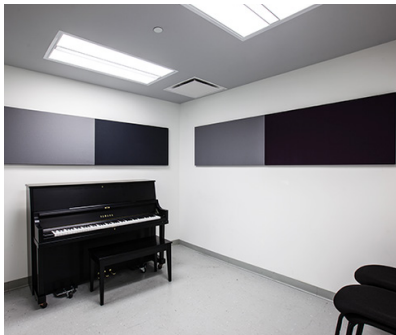

Studio 803

90 sq ft | 10' Ceiling

